

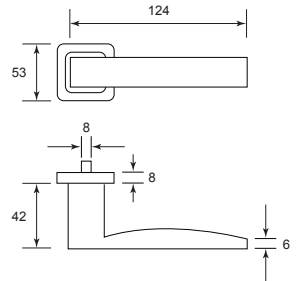

## Melbourne Series

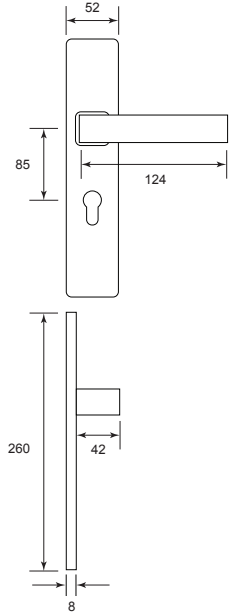

## Perth Series

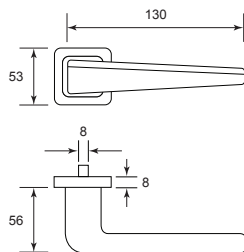
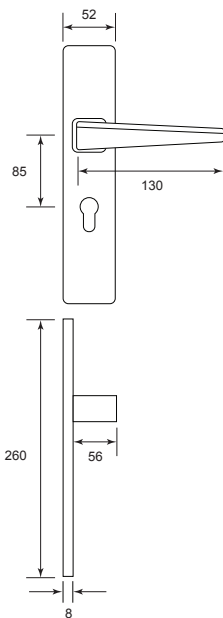

**Gold Coast Series**

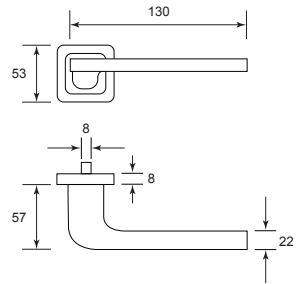
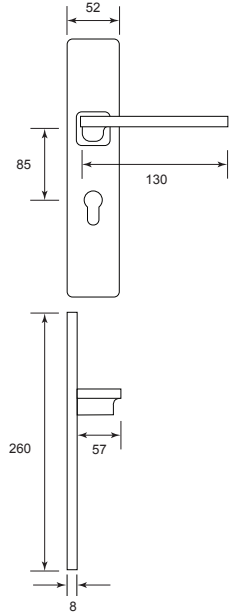

# DESIGNER LEVER HANDLE



## Queensland Series

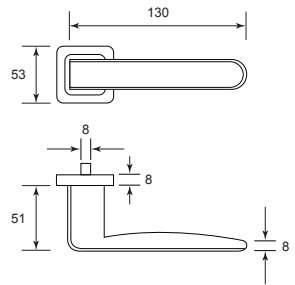
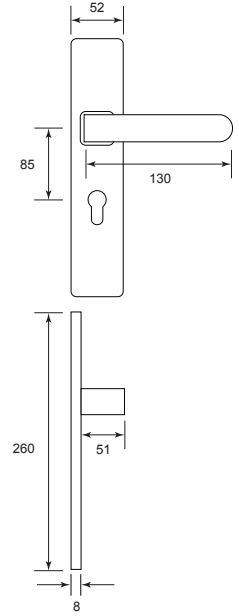

## Mackay Series

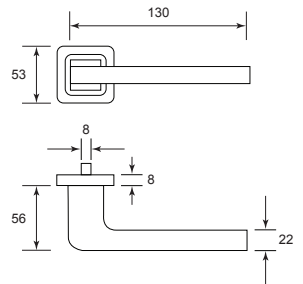
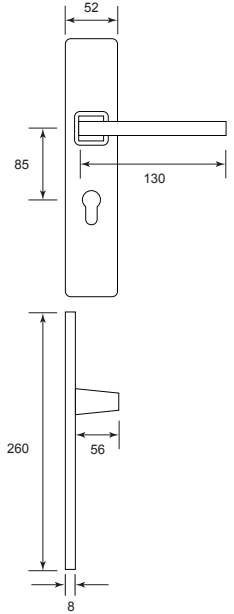

# DESIGNER LEVER HANDLE



## Sydney Series

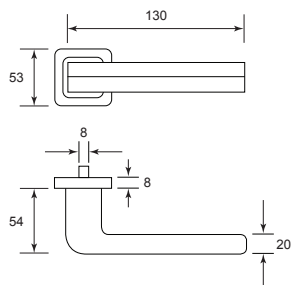
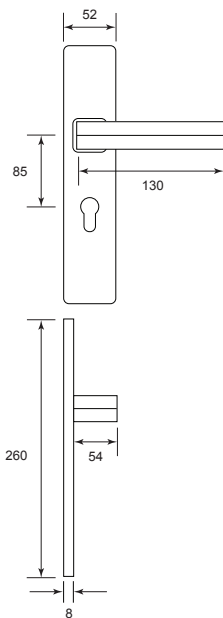

## Melbourne Series

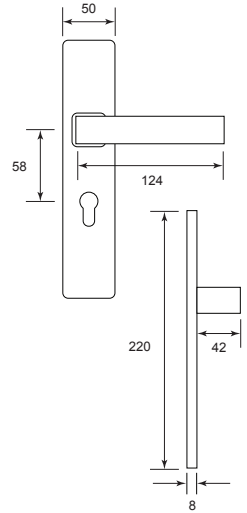

## Perth Series

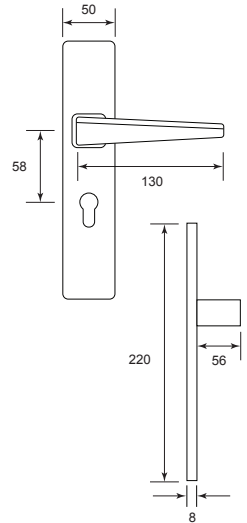



# DESIGNER LEVER HANDLE



## Gold Coast Series

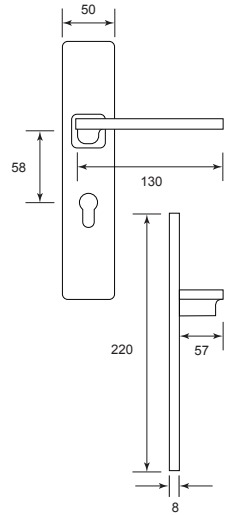
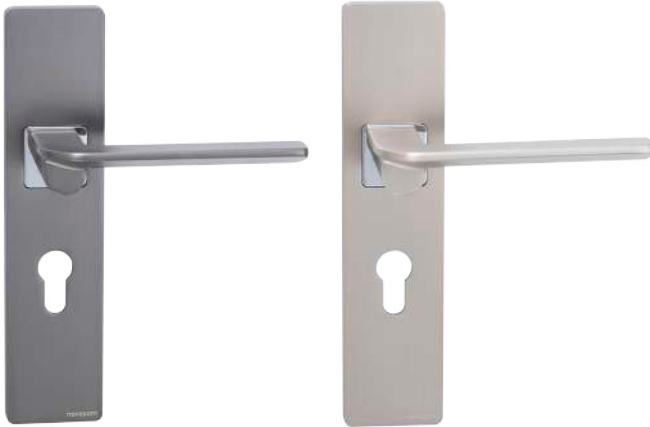

\* The above price are included mortise lock 50mm x 58mm and 60mm single profile cylinder

## Advantages



Solid lever handle for superior strength



Double layer lever handle on plate for new door & replacement market for 50mm x 58mm mortise.



Concealed screws for both side offer clean look



Wide selection of matching series to create a perfect look for your home

## Privacy Series - Melbourne & Perth

**SPECIFICATIONS:**

- Door Thickness : 1 $\frac{3}{8}$ " to 1 $\frac{3}{4}$ " (35mm - 45mm)
- Backset : 2 $\frac{3}{8}$ " (60mm)

Internal Trim Plate

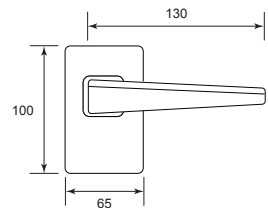
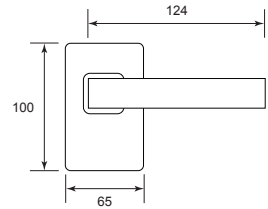

# DESIGNER LEVER HANDLE



## Privacy Series - Gold Coast

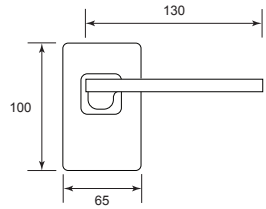
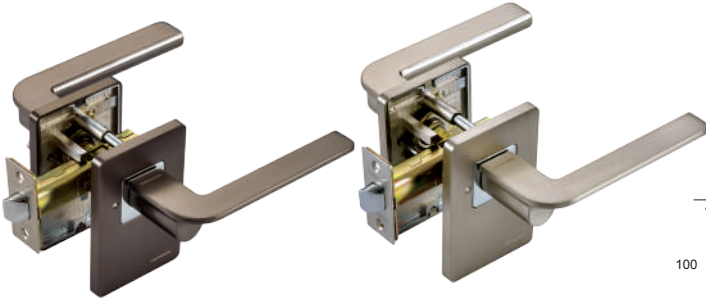

### Advantages



First grade zinc alloy solid handle provides fine finishing and excellent strength.



Concealed mounting screws for both side offer clean upgraded appearance.



Panic function for emergency exit.

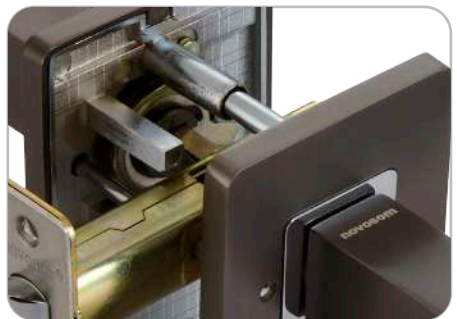

Well designed system to eliminate lever sagging.

## ADVANTAGES



Ultra Slim **5**

Ultra slim trim plate offer timeless beauty which demands by designers market.

# ULTRA SLIM 5 LEVER HANDLE



## Auckland Series

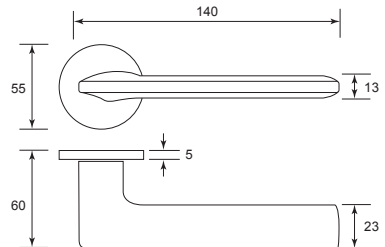
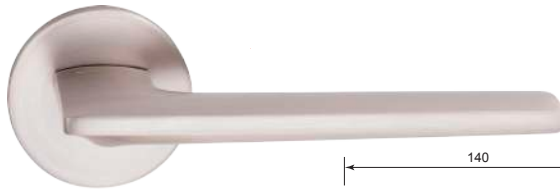
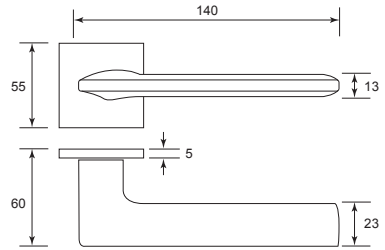
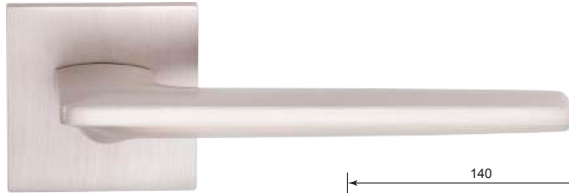

## Wellington Series

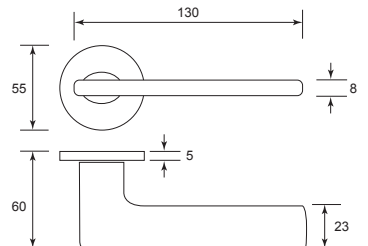
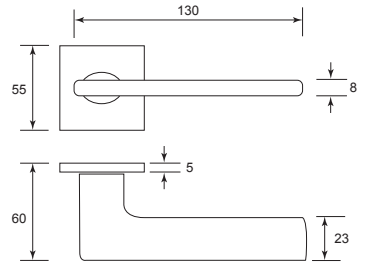

## Alexandra Series

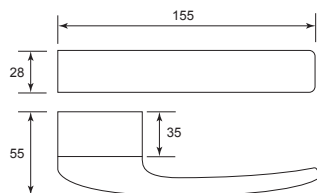

## Gisborne Series

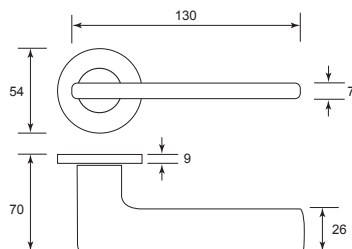

## Augusta Series

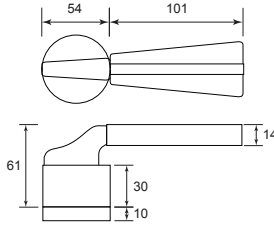

## ADVANTAGES



New concepts of concealed base model gives elegant and decorative upgrade.

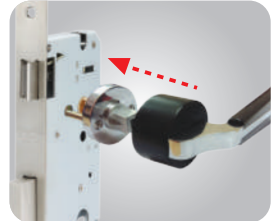

Bolt through screws provide greater strength and durability.



Solid metal construction lever handle for superior strength.



Human Engineering designs to inspire gripping comfort.

## Bunbury Series

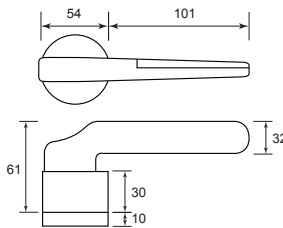



## Stainless Steel Lever Handle On Plate

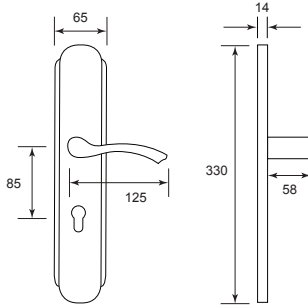

### ADVANTAGES



Concealed screws for exposed trim plate offer clean look



Reversible lever handle for easy operation



Genuine SUS 304 material to resist corrosion

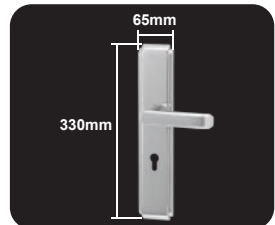
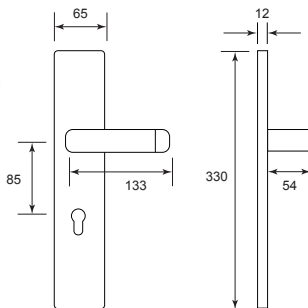
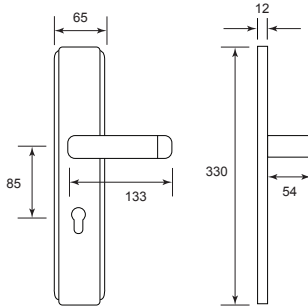

Wider plate - suitable for replacement market and new door

# Stainless Steel Lever Handle On Plate

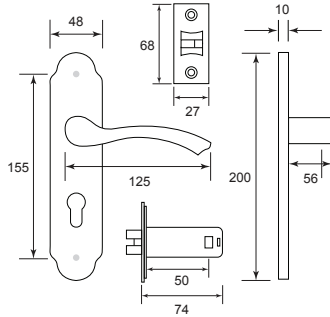

## ADVANTAGES



Concealed screws for exposed trim plate offer clean look

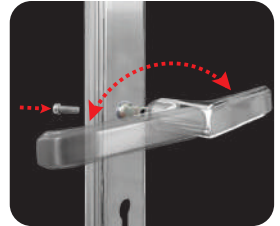
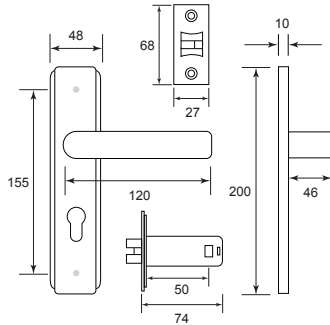

Reversible lever handle for easy operation

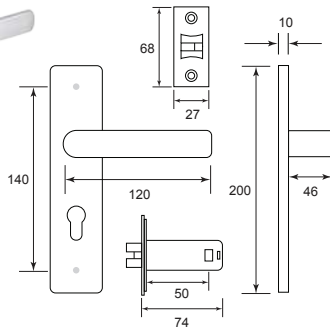

Genuine SUS 304 material to resist corrosion



Lever handle on plate operates with latch for easy installation

# PUSH & PULL LOCK



## Privacy Series

### SPECIFICATIONS:

- Door Thickness : 1 3/8" to 2" (35mm - 51mm)
- Backset : 2 3/8" (60mm)

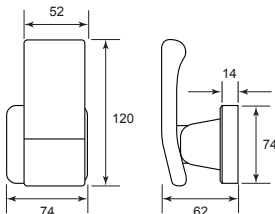

## ADVANTAGES



New concept of push pull slim handle with human engineering designs to inspire gripping comfort.



Concealed mounting screws offer clean appearance.



Panic function for emergency exit.



Well-design spring latch to reduce latching sound when closing the door.

## Privacy Series

### SPECIFICATIONS:

- Door Thickness : 1 3/8" to 2" (35mm - 51mm)
- Backset : 2 3/8" (60mm)



### ADVANTAGES



New concept of human engineering design push pull slim handle offer gripping comfort



Concealed fixing screws give clean appearance



Unique rotating latch provides easiest & comfortable way to open a door

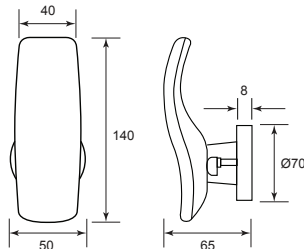
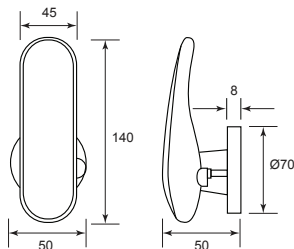

Panic function for emergency exit.

## Sliding Door Track - Double Soft Close

### Specification:

- For 1 & 2 Sliding Wooden Doors
- Height Adjustable
- Max. Door Weight: 80kg per door
- Min. Door Thickness: 30mm
- Min. Door Width: 600mm

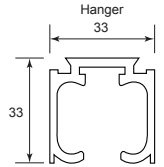

Buffering Roller

Floor Guide

Stir Button

### Optional:

#### End Track Cover

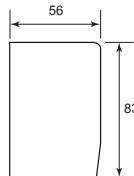

#### Side Mounting Hanger

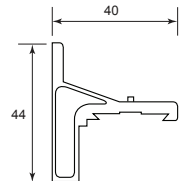

#### Side Mounting Decoration Cover

- Length: 2 metre



#### Down Rail

- Length: 3 metre

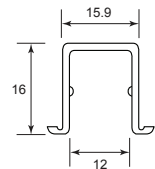

## Mortise

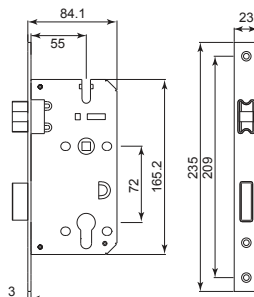
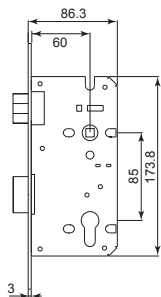
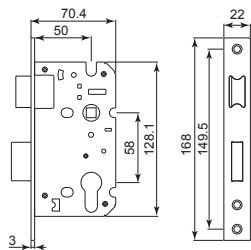
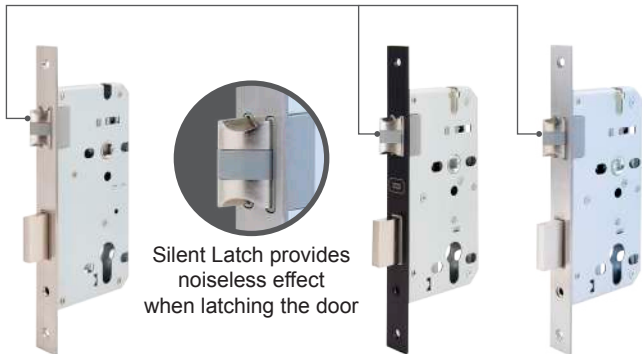

## Accessories

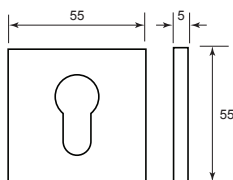
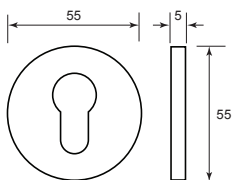

## Latch

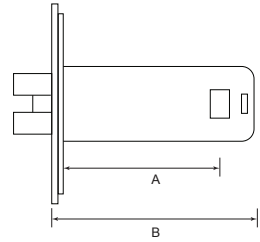

Code No.	Size (A)	Size (B)
NVS-B30MM	30mm	42mm
NVS-B45MM	45mm	62mm
NVS-B50MM	50mm	74mm
NVS-B60MM	60mm	84mm
NVS-B70MM	70mm	98mm
NVS-B90MM	90mm	106mm

## Merchandise Stand



